

ACO Installation Device Install

Tools

- Hammer
 - Spirit level
 - Tape measure
 - 2 x String lines & pegs
 - 12mm ring spanner / crescent wrench
 - 16mm diameter reinforcing bars.
- Lengths to be determined by installer.
Bar lengths will vary depending on soil type and height of channel above the trench depth.
- Number of reinforcing bars required:
2 per channel + 2 for the end channel
- 1.1m length of timber to assist with leveling.
 - Installation devices:
1 per channel + 1 for the end channel

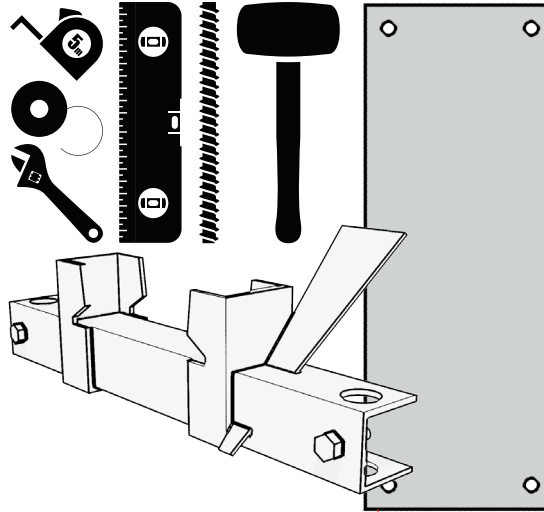

Installation Device Setup

- Loosen both screws to allow the device to be positioned over the reinforcing bars.
- Push the adjustable clamp to the outside to allow the channels to be installed.
- Wedge is fitted during final stage of installation.

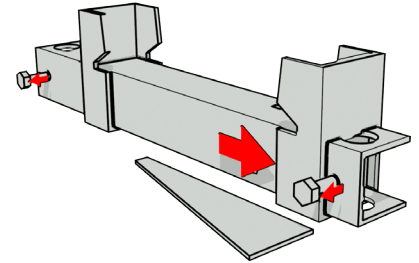

Step 1

Create the required width template using timber sheet or similarly suitable rigid material. Diagrams can be printed from the ACO website.
For ACO's KlassikDrain and PowerDrain System:
<http://www.acodrain.us/technical.html>



Step 2

Set out the top string line for the top edge of the channel run and lay the required channels in sequence along the string line. Also lay out 2 reinforcing bars and 1 installation device at the location of each channel joint.

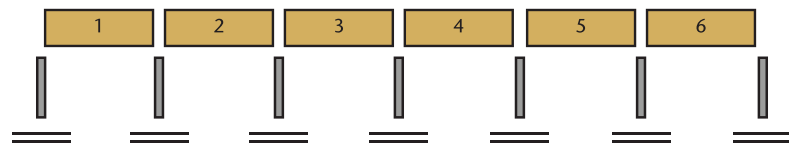

Step 3

Set the first channel without using the template to allow for flexibility. Note: The first channel to be set out must be at the outlet/deep end of the run. The fixed side of the installation device must be on the same side of the channel as the string line. Ensure the reinforcing bars are adequately pushed into the ground so they do not fall over once the channel is removed and do not sit higher than the top of the channel.

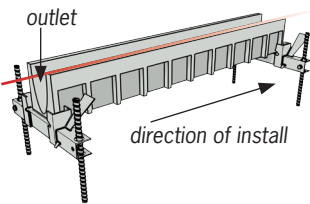

Step 4

Once the first channel is set, leveled and straightness is achieved, remove the channel and leave the first installation device in place. Remove the second device, but leave the reinforcing bars in place.

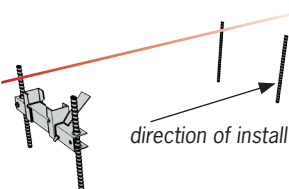

Step 5

Position the template over the second row of reinforcing bars.

Step 6

Set up the second string line up against the template edge ensuring that both string lines are parallel. The second string line should be just above the ground level to keep the template straight when moving from one channel to the next. The string line should also be on the same side of the channel as the top string line.

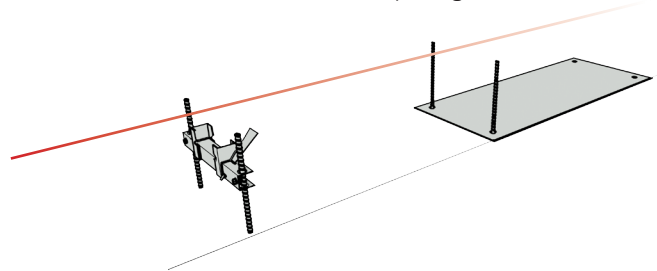

Step 7

Hammer in the next/third row of re-bar through the empty template holes. Drive the reinforcing bars into a sufficient depth, but not too low to stop the use of the Installation Device.

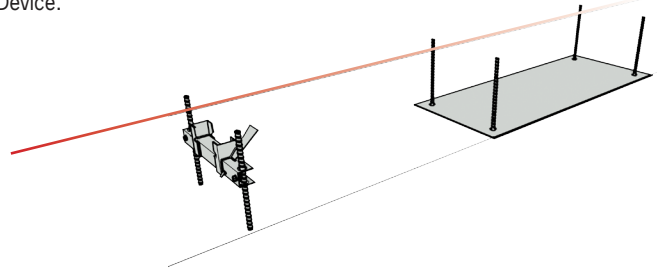

Step 8

Remove the template and reposition the template again on the last two reinforcing bars that were just installed.

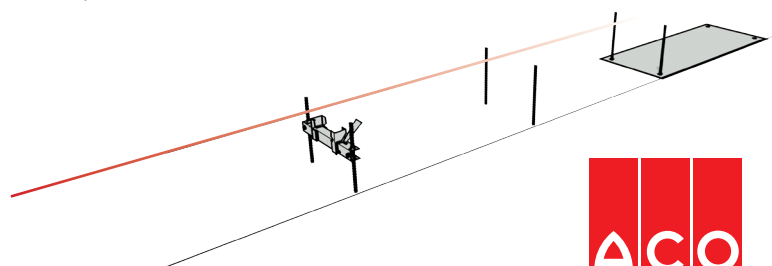

ACO Installation Device Install

Step 9

Re-attach the second installation device to the second row of reinforcing bars.

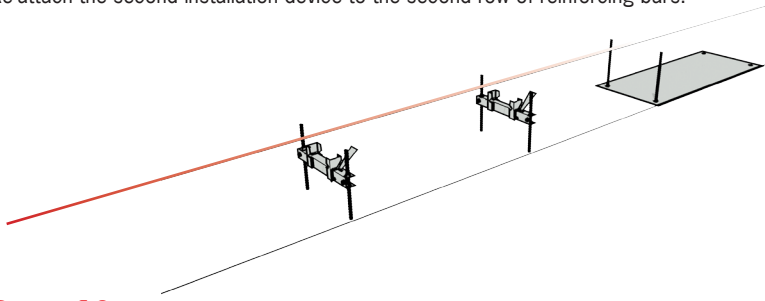

Step 10

Replace the first channel WITHOUT securing it and ensure the channel is level with the top string line and is level across the width of the channel. If it's too high, tap down the reinforcing bars. If it's too low, undo the screws and lift the installation device up.

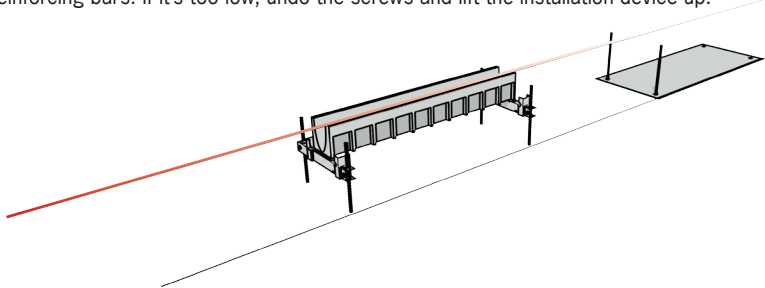

Once the first channel has been replaced, DO NOT lock the adjustable side of the clamp with the wedge yet. This allows some movement of the channel when placing the next channel in line. Do not place the channel all the way to the fixed side of the clamp where it will sit in the locked position. This allows for easier installation of channels.

Note: Always allow two sets of reinforcing bars to be installed before placing channels. This allows the template to be removed and placed into the next position for setting the reinforcing bars.

Step 11

Continue to install devices and repeat process of setting the channels.

Step 12

After the next/fourth channel is set, the first channel can be locked into position using the wedges for the install device.

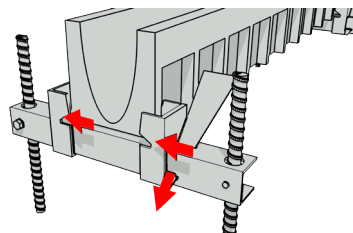

Note: Ensure the reinforcing bars are installed at least 2 rows ahead prior to installing channels.

Step 13

Continue to follow steps 7 to 13 until the trench run is complete and ensure all the wedges are in place. Channels are now set up for a single concrete pour operation. The installation device clamps the channels together to brace the channels in place and prevent movement during the concrete pour.

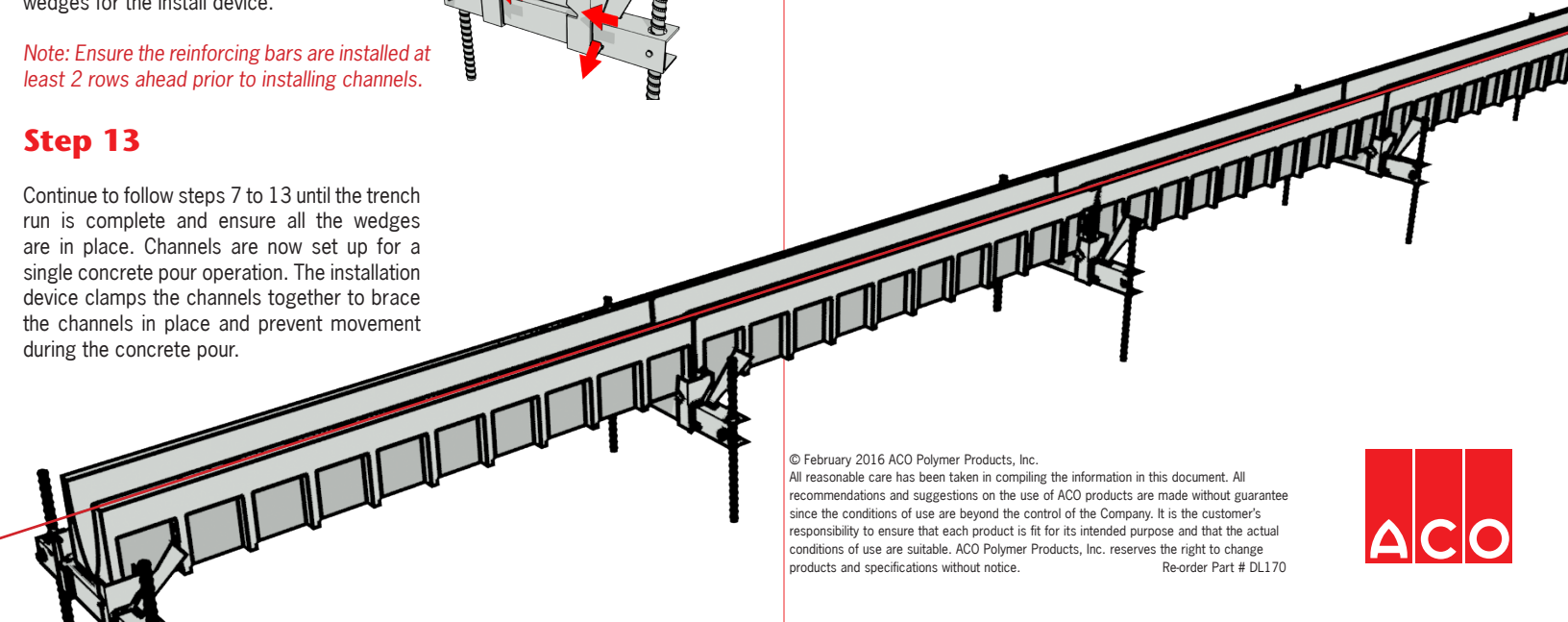
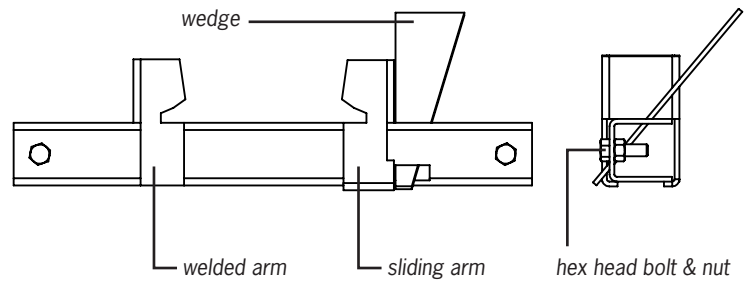

© February 2016 ACO Polymer Products, Inc.
All reasonable care has been taken in compiling the information in this document. All recommendations and suggestions on the use of ACO products are made without guarantee since the conditions of use are beyond the control of the Company. It is the customer's responsibility to ensure that each product is fit for its intended purpose and that the actual conditions of use are suitable. ACO Polymer Products, Inc. reserves the right to change products and specifications without notice.
Re-order Part # DL170

